

PRODUCT SPECIFICATION

4.3" a-Si TFT LCD MODULE

MODEL: T043480272-A7TMN-001 Ver:1.3

ROHS

< ◇ > Preliminary Specification

< ◆ > Finally Specification

CUSTOMER'S APPROVAL	
CUSTOMER :	
SIGNATURE:	DATE:

APPROVED BY	PM REVIEWED	PD REVIEWED	PREPARED BY

Revision History

Revision	Date	Originator	Detail	Remarks
Ver 1.0	2017.02.22	ZFY	Initial Release	
Ver 1.1	2017.04.06	LJ	Modify Outline	P27
1.2	2017.05.10	ZFY	Add weight Add current Add chromaticity	P4 P5 P6
1.3	2017.06.05	ZFY	Modify AC characteristic & Timing	P11-P15

WWW.SUNLCD.NET

Table of Contents

No.	Item	Page
1.	General Description.....	4
2.	Module Parameter.....	4
3.	Absolute Maximum Ratings.....	4
4.	DC Characteristics	5
5.	Backlight Characteristic.....	5
5.1.	Backlight Characteristics	5
5.2.	Backlighting circuit.....	5
6.	Optical Characteristics	6
6.1.	Optical Characteristics	6
6.2.	Definition of Response Time	6
6.3.	Definition of Contrast Ratio	7
6.4.	Definition of Viewing Angles	7
6.5.	Definition of Color Appearance.....	8
6.6.	Definition of Surface Luminance, Uniformity and Transmittance.....	8
7.	Block Diagram and Power Supply.....	9
8.	Interface Pins Definition	10
9.	AC Characteristics and RGB Input Timing.....	11
10.	Quality Assurance	16
10.1	Purpose	16
10.2	Standard for Quality Test	16
10.3	Nonconforming Analysis & Disposition.....	16
10.4	Agreement Items	16
10.5	Standard of the Product Visual Inspection	16
10.6	Inspection Specification	17
10.7	Classification of Defects.....	22
10.8	Identification/marketing criteria.....	22
10.9	Packing.....	22
11.	Reliability Specification.....	23
12.	Precautions and Warranty.....	24
12.1	Safety	24
12.2	Handling	24
12.3	Storage	24
12.4	Metal Pin (Apply to Products with Metal Pins)	24
12.5	Operation.....	25
12.6	Static Electricity	25
12.7	Limited Warranty	25
13.	Packaging.....	26
14.	Outline Drawing.....	27

1. General Description

The specification is a transmissive type color active matrix liquid crystal display (LCD) which uses amorphous thin film transistor (TFT) as switching devices. This product is composed of a TFT-LCD panel, driver ICs and a backlight unit.

2. Module Parameter

Features	Details	Unit
Display Size(Diagonal)	4.3"	
LCD type	TN TFT	
Display Mode	Transmissive /Normally white	
Resolution	480 RGB x 272	Pixels
View Direction	12 O'clock	Best Image
Gray Scale Inversion Direction	6 O'clock	
Module Outline	105.5(H) x 67.2 (V) x 2.9 (T) (Note 1)	mm
Active Area	95.04(H) x 53.856(V)	mm
Pixel Pich	198(H) x 198(V)	um
Pixel Arrangement	RGB Stripe	
Polarizer Surface Treatment	Normal	
Display Colors	16M	
Interface	24-bit RGB Interface	
Driver IC	ST7282	-
With or Without Touch Panel	Without	
Operating Temperature	-20 ~ 70	°C
Storage Temperature	-30 ~ 80	°C
Weight	41	g

Note 1: Exclusive hooks, posts, FFC/FPC tail etc.

3. Absolute Maximum Ratings

$V_{SS}=0V$, $T_a=25^{\circ}C$

Item	Symbol	Min.	Max.	Unit
Supply Voltage	VDD	-0.3	4.6	V
Storage temperature	T_{STG}	-30	+80	°C
Operating temperature	T_{OP}	-20	+70	°C

Note 1: If T_a below $50^{\circ}C$, the maximal humidity is 90%RH, if T_a over $50^{\circ}C$, absolute humidity should be less than 60%RH.

Note 2: The response time will be extremely slow when the operating temperature is around $-10^{\circ}C$, and the back ground will become darker at high temperature operating.

4. DC Characteristics

Item	Symbol	Min.	Typ.	Max.	Unit	
Supply Voltage	VDD	3.0	3.3	3.6	V	
Logic Low input voltage	V _{IL}	0	-	0.3*VDD	V	
Logic High input voltage	V _{IH}	0.7*VDD	-	VDD	V	
Logic Low output voltage	V _{OL}	0	-	0.4	V	
Logic High output voltage	V _{OH}	VDD-0.4	-	VDD	V	
Current Consumption All Black	Logic Analog	I _{CC+} I _{IN}	-	(25)	-	mA

5. Backlight Characteristic

5.1. Backlight Characteristics

Item	Symbol	Condition	Min	Typ	Max	Unit
Forward Voltage	V _F	T _a =25 °C, I _F =20mA/LED	19.6	22.4	23.8	V
Forward Current	I _F	T _a =25 °C, V _F =3.2V/LED	-	20	-	mA
Power dissipation	P _D		-	448	-	mW
Uniformity	Avg		-	80	-	%
Drive method	Constant current					
LED Configuration	7 White LEDs in serial					

5.2. Backlighting circuit

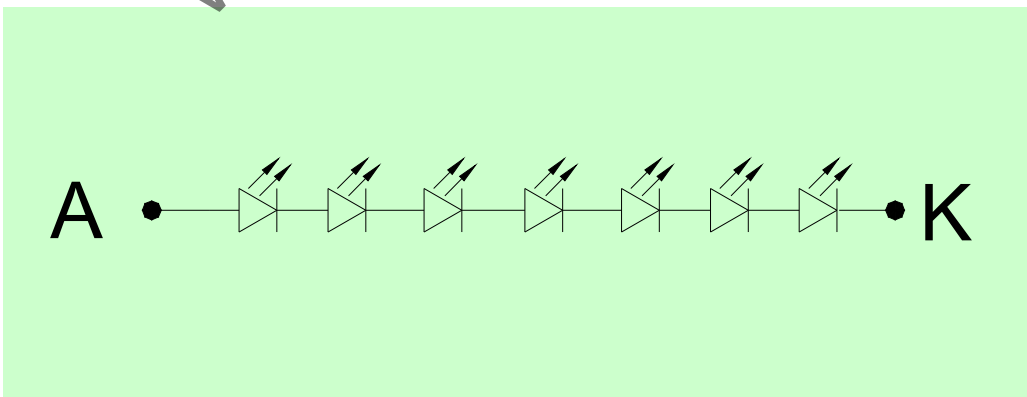

6. Optical Characteristics

6.1. Optical Characteristics

Ta=25°C, VDD=3.3V, TN LC+ Polarizer

	Item	Symbol	Condition	Specification			Unit	
				Min.	Typ.	Max.		
Backlight On (Transmissive Mode)	Luminance on TFT($I_f=20\text{mA/LED}$)	Lv	Normally viewing angle $\theta_x = \phi_y = 0^\circ$	240	300	-	cd/m ²	
	Contrast ratio(See 6.3)	CR		-	500	-		
	Response time (See 6.2)	T _R		-	25	50	ms	
		T _F						
	Chromaticity Transmissive (See 6.5)	Red	X _R	Center CR≥10	0.555	0.605	0.655	
			Y _R		0.316	0.366	0.416	
		Green	X _G		0.281	0.331	0.381	
			Y _G		0.537	0.587	0.637	
		Blue	X _B		0.093	0.143	0.193	
			Y _B		0.025	0.075	0.125	
White	X _W	0.269	0.319	0.369				
	Y _W	0.309	0.359	0.409				
Viewing Angle (See 6.4)	Horizontal	θ_{x+}	Center CR≥10	55	70	-	Deg.	
		θ_{x-}		55	70	-		
	Vertical	ϕ_{y+}		35	50	-		
		ϕ_{y-}		55	70	-		
NTSC Ratio(Gamut)				40	50	-	%	

6.2. Definition of Response Time

6.2.1. Normally Black Type (Negative)

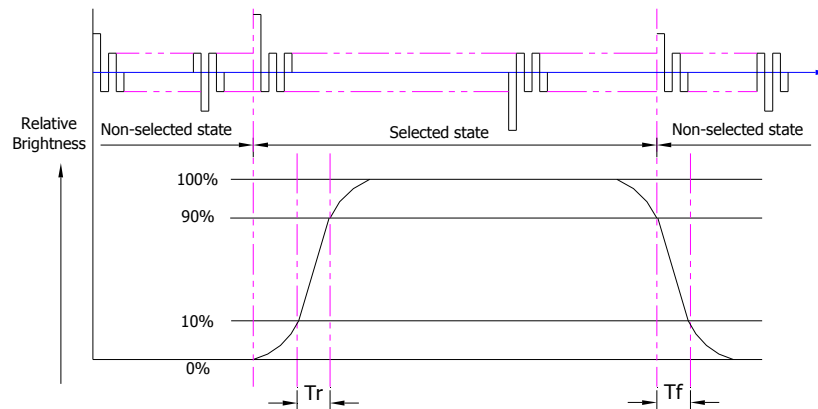

Tr is the time it takes to change from non-selected stage with relative luminance 10% to selected state with relative luminance 90%;

Tf is the time it takes to change from selected state with relative luminance 90% to non-selected state with relative luminance 10%.

Note : Measuring machine: LCD-5100

6.2.2. Normally White Type (Positive)

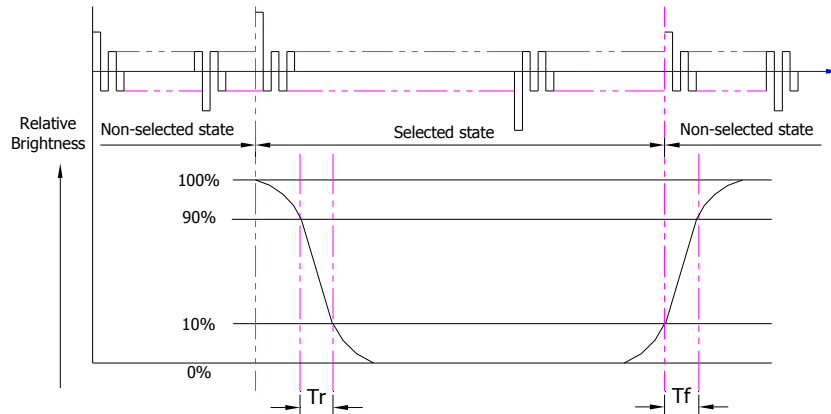

Tr is the time it takes to change from non-selected state with relative luminance 90% to selected state with relative luminance 10%;

Tf is the time it takes to change from selected state with relative luminance 10% to non-selected state with relative luminance 90%;

Note : Measuring machine: LCD-5100 or EQUI.

6.3. Definition of Contrast Ratio

Contrast is measured perpendicular to display surface in reflective and transmissive mode.

The measurement condition is:

Measuring Equipment	Eldim or Euivelent
Measuring Point Diameter	3mm//1mm
Measuring Point Location	Active Area centre point
Test pattern	A: All Pixels white
	B: All Pixel black
Contrast setting	Maximum

Definitions: CR (Contrast) = Luminance of White Pixel / Luminance of Black Pixel

6.4. Definition of Viewing Angles

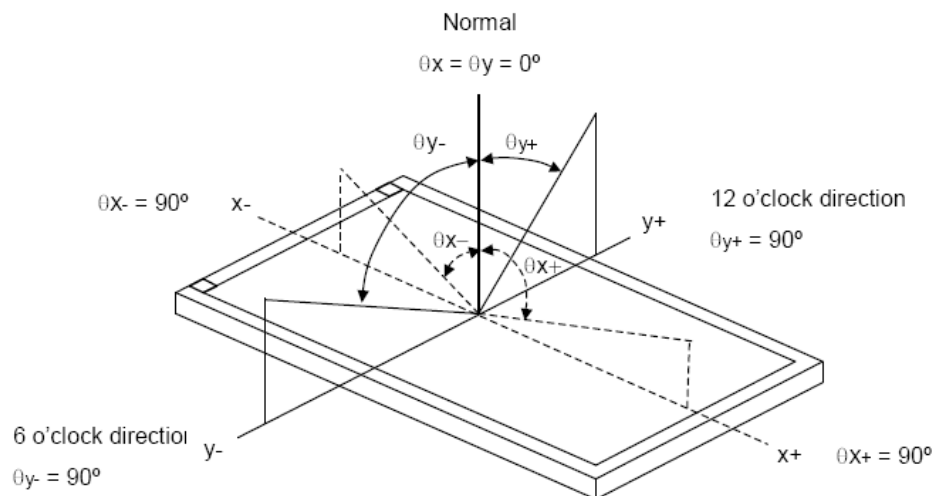

Measuring machine: LCD-5100 or EQUI

6.5. Definition of Color Appearance

R,G,B and W are defined by (x, y) on the IE chromaticity diagram

NTSC=area of RGB triangle/area of NTSC triangleX100%

Measuring picture: Red, Green, Blue and White (Measuring machine: BM-7)

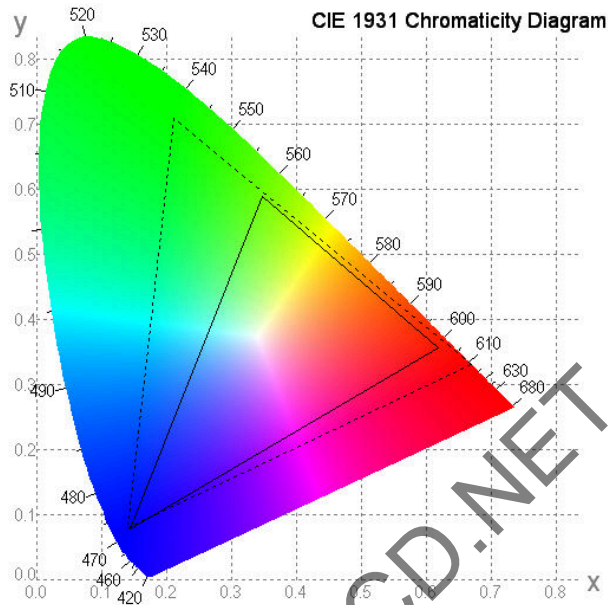

6.6. Definition of Surface Luminance, Uniformity and Transmittance

Using the transmissive mode measurement approach, measure the white screen luminance of the display panel and backlight.

6.6.1. Surface Luminance: $L_v = \text{average } (L_{P1}:L_{P9})$

6.6.2. Uniformity = Minimal ($L_{P1}:L_{P9}$) / Maximal ($L_{P1}:L_{P9}$) * 100%

6.6.3. Transmittance = L_v on LCD / L_v on Backlight * 100%

Note : Measuring machine: BM-7

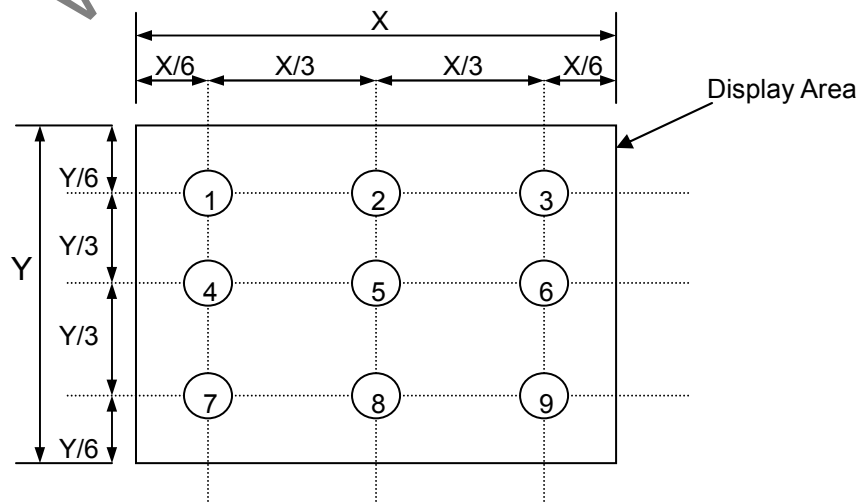

7. Block Diagram and Power Supply

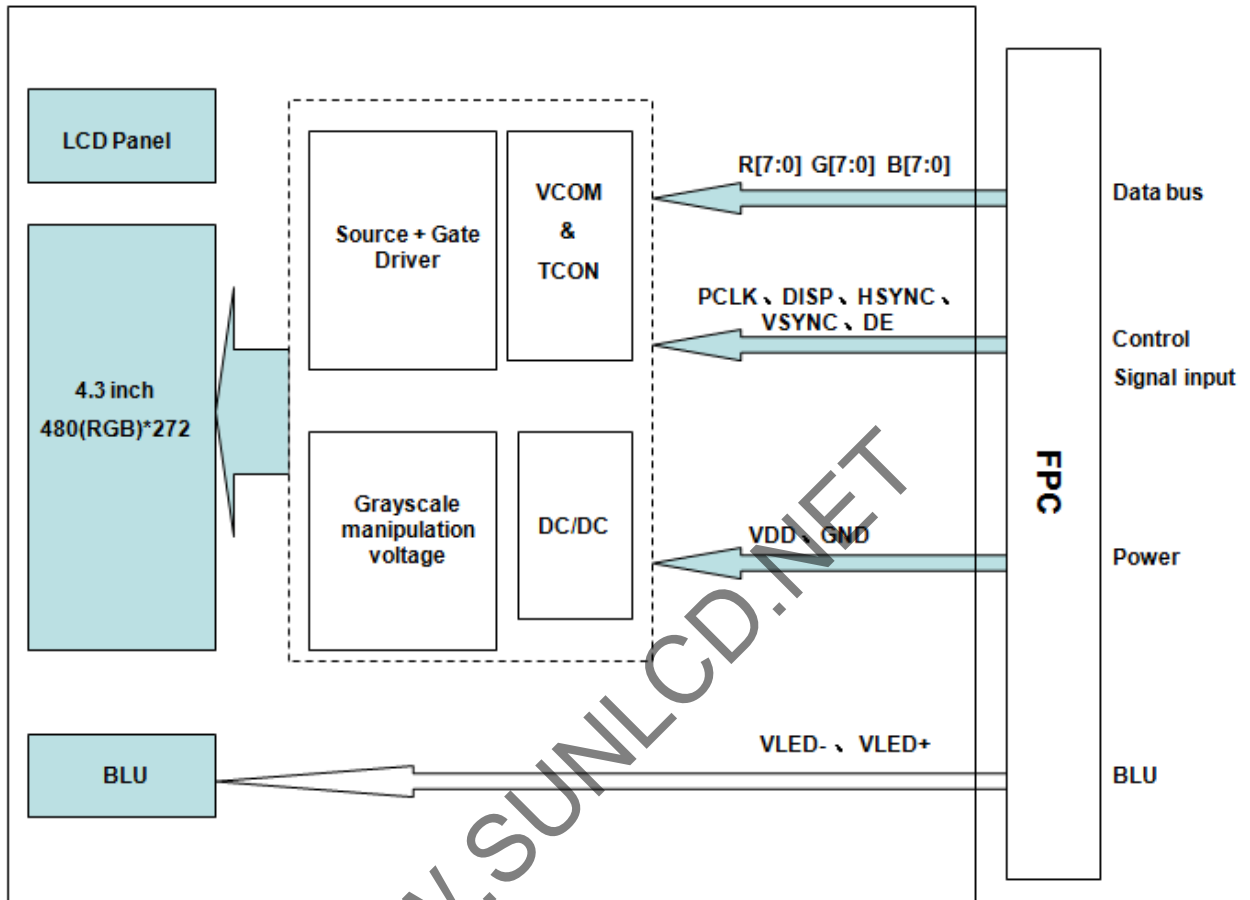

8. Interface Pins Definition

No.	Symbol	Function	Remark
1	VLED-	Backlight Cathode	
2	VLED+	Backlight Anode	
3	GND	Ground	
4	VDD	Power source	
5	R0	Red data signal	
6	R1	Red data signal	
7	R2	Red data signal	
8	R3	Red data signal	
9	R4	Red data signal	
10	R5	Red data signal	
11	R6	Red data signal	
12	R7	Red data signal	
13	G0	Green data signal	
14	G1	Green data signal	
15	G2	Green data signal	
16	G3	Green data signal	
17	G4	Green data signal	
18	G5	Green data signal	
19	G6	Green data signal	
20	G7	Green data signal	
21	B0	Blue data signal	
22	B1	Blue data signal	
23	B2	Blue data signal	
24	B3	Blue data signal	
25	B4	Blue data signal	
26	B5	Blue data signal	
27	B6	Blue data signal	
28	B7	Blue data signal	
29	GND	Ground	
30	PCLK	Clock signal to sample each data	
31	DISP	Display on/off signal DISP="H" Display on DISP="L" Display off	
32	Hsync	Horizontal synchronizing signal	
33	Vsync	Vertical synchronizing signal	
34	DE	Input data enable control.	
35	NC	No connection	
36	GND	Ground	
37-40	NC	No connection	

9. AC Characteristics and RGB Input Timing

9.1 AC Characteristics

Item	Symbol	Min.	Typ.	Max.	Unit	Conditions
System operation timing						
VDD power source slew time	TPOR	-	-	20	ms	From 0V to 99% VDD
GRB pulse width	tRSTW	10	50	-	us	R=10Kohm, C=1uF
Input/ Output timing						
CLK pulse duty	Tcw	40	50	60	%	
Hsync width	Thw	1	-	-	DCLK	
Hsync period	Th	55	60	65	us	
Vsync setup time	Tvst	12	-	-	ns	
Vsync hold time	Tvhd	12	-	-	ns	
Hsync setup time	Thst	12	-	-	ns	
Hsync hold time	Thhd	12	-	-	ns	
Data setup time	Tdsu	12	-	-	ns	
Data hold time	Tdhd	12	-	-	ns	
DE setup time	Tdest	10	-	-	ns	
DE setup time	Tdehd	10	-	-	ns	
SD output stable time	Tst	-	-	12	us	Output settled within +20mV Loading = 6.8k+28.2pF.
GD output rise and fall time	Tgst	-	-	6	us	Output settled (5%~95%), Loading = 4.7k+29.8pF

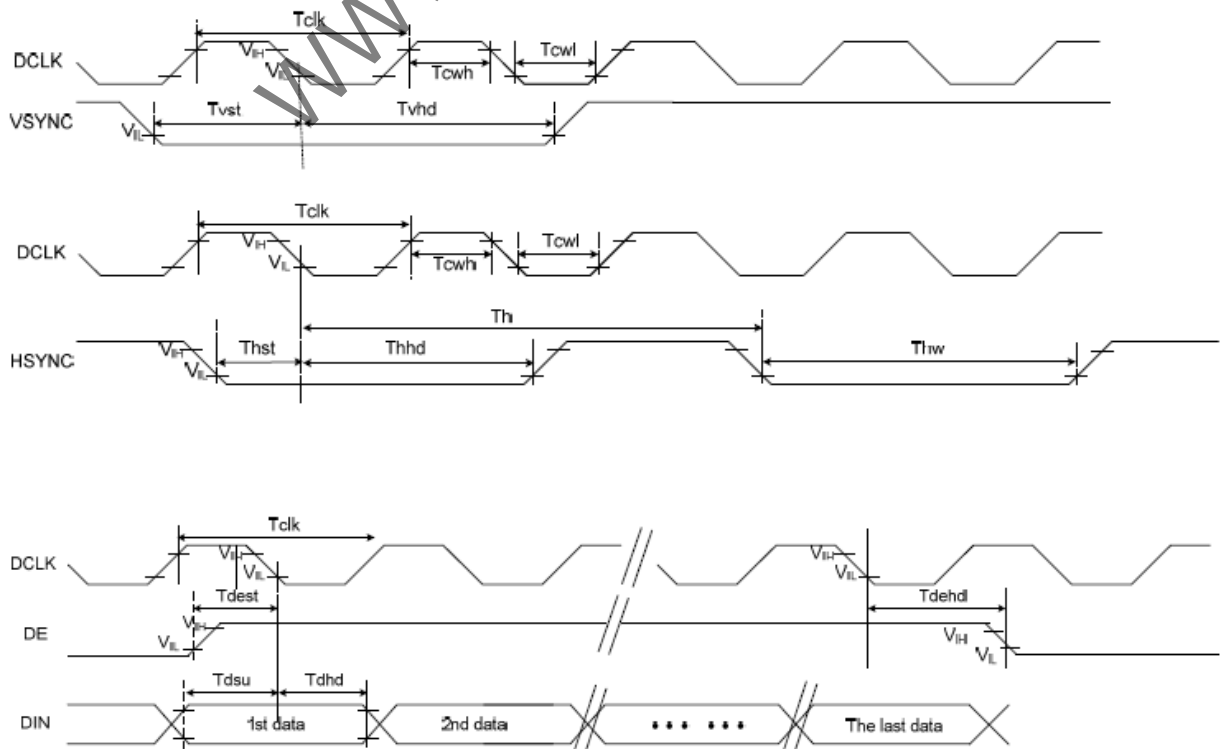

9.2 RGB input Timing

1) Parallel 24-bit RGB Timing Table

Item	Symbol	Min.	Typ.	Max.	Unit	Remark	
DCLK Frequency	Fclk	8	9	12	MHz		
DCLK Period	Tclk	83	111	125	ns		
HSYNC	Period Time	Th	485	531	598	DCLK	
	Display Period	Thdisp		480		DCLK	
	Back Porch	Thbp	3	43	43	DCLK	By H_Blanking setting
	Front Porch	Thfp	2	8	75	DCLK	
	Pulse Width	Thw	2	4	75	DCLK	
VSYNC	Period Time	Tv	276	292	321	H	
	Display Period	Tvdisp		272		H	
	Back Porch	Tvbp	2	12	12	H	By V_Blanking setting
	Front Porch	Tvfp	2	8	37	H	
	Pulse Width	Tvw	2	4	37	H	

Note: It is necessary to keep $Tvbp = 12$ and $Thbp = 43$ in sync mode. DE mode is unnecessary to keep it.

2) SYNC Mode Timing

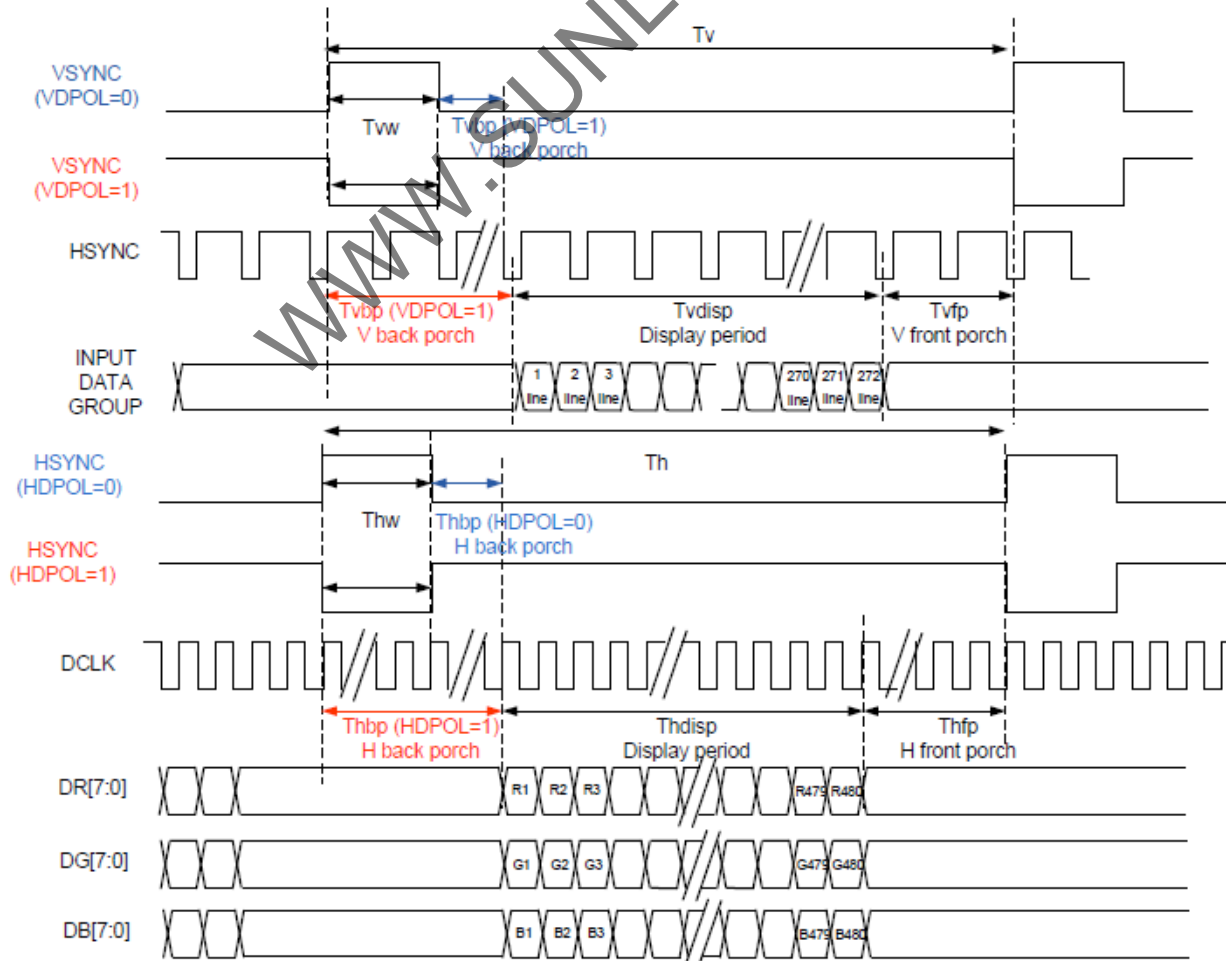

3) SYNC-DE Mode Timing Diagram

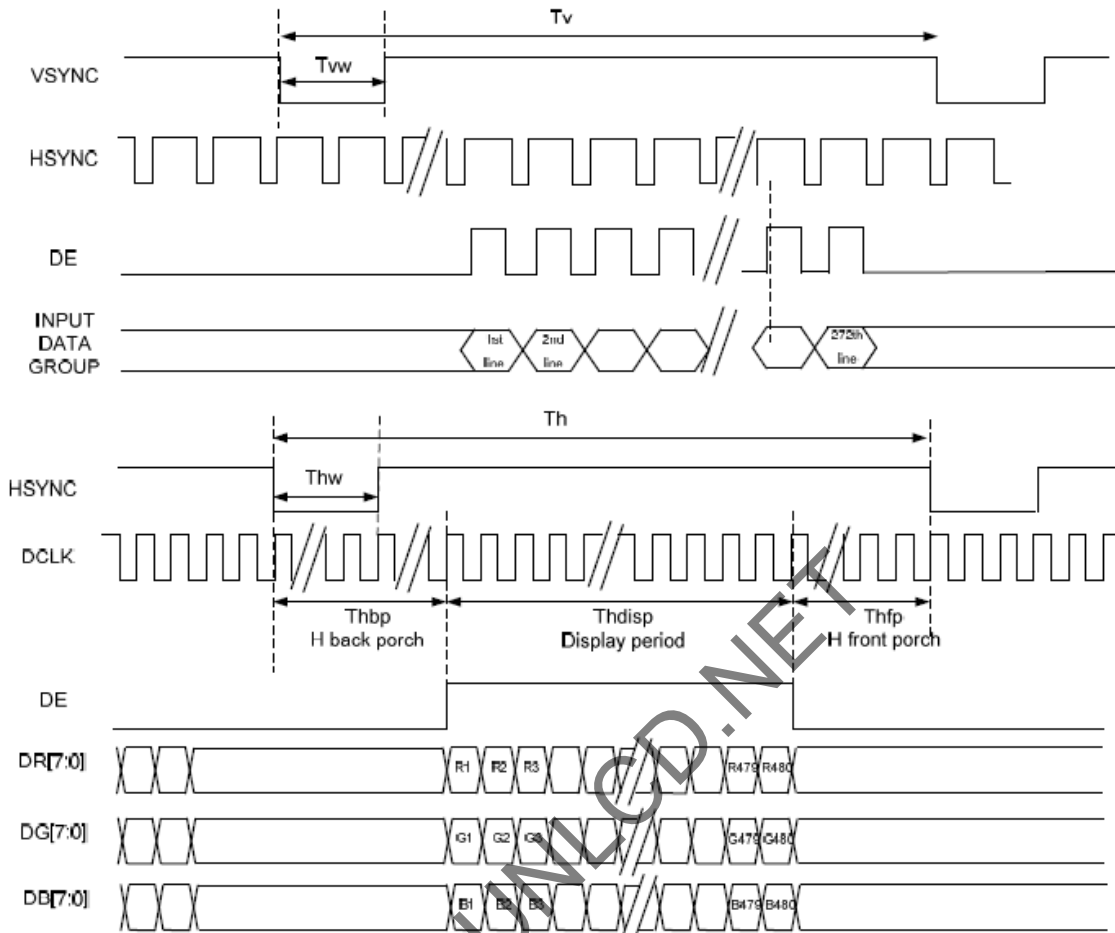

4) DE Mode Timing Diagram

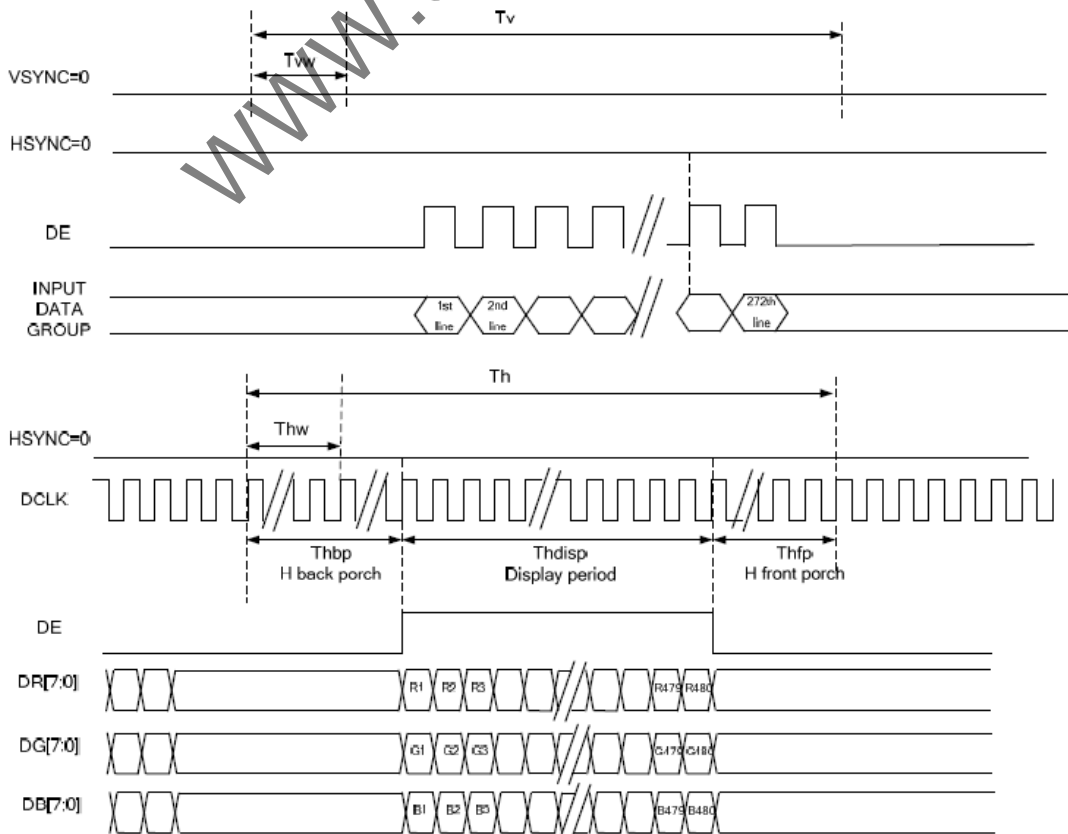

9.3 POWER ON/OFF SEQUENCE

1) Power On Sequence

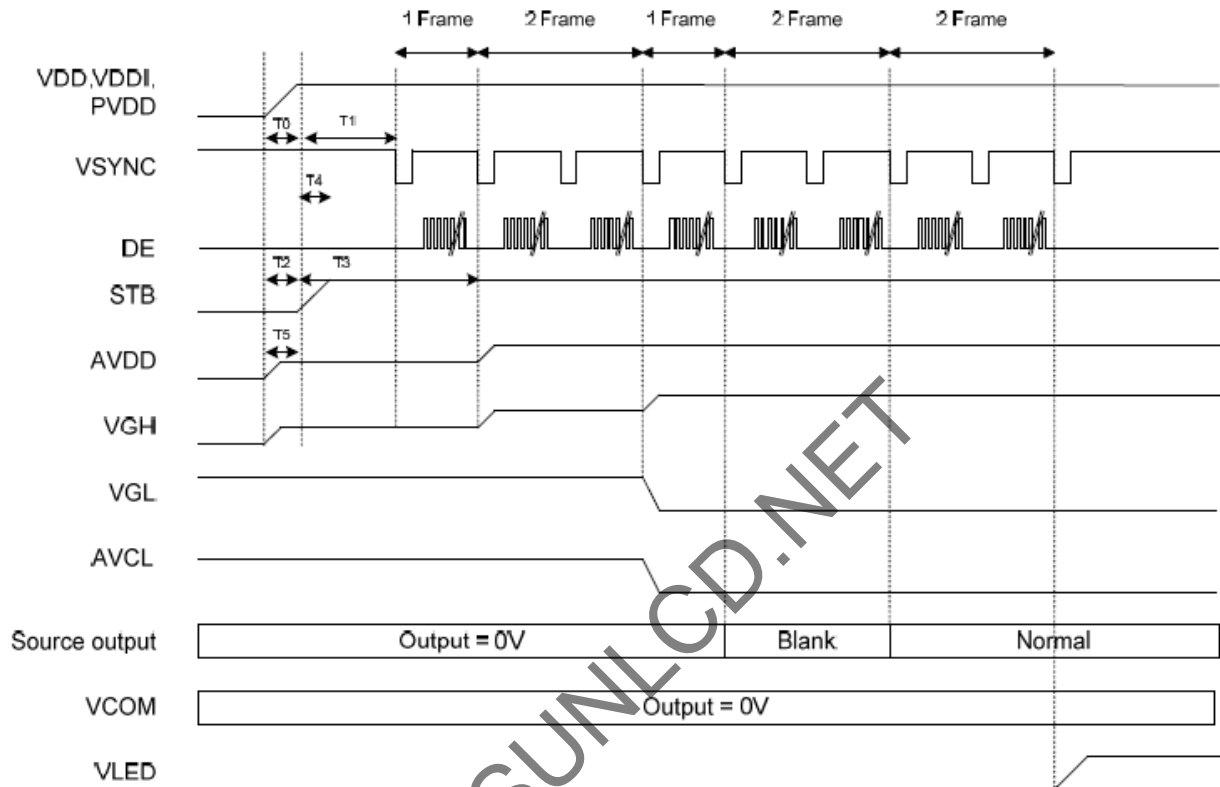

	Description	Min. Time
T0	Determined by the external power	
T1	Time from stable VDD, VDDI, PVDD set-up to the first VSYNC	T1=0
T2	Time from AVDD=0V to AVDD=3.3V	T2=T0
T3	Time from AVDD=3.3V to AVDD=6.0V	T3=T1+ (1*Frame)
T4	Time from stable VDD, VDDI, PVDD set-up to DISP asserted	T4=0
T5	Time from VGH=0V to VGH=3.3V	T5=T0

Note: Recommend the LCM power on rise time T0= 0~ 1ms

2) Power Off Sequence

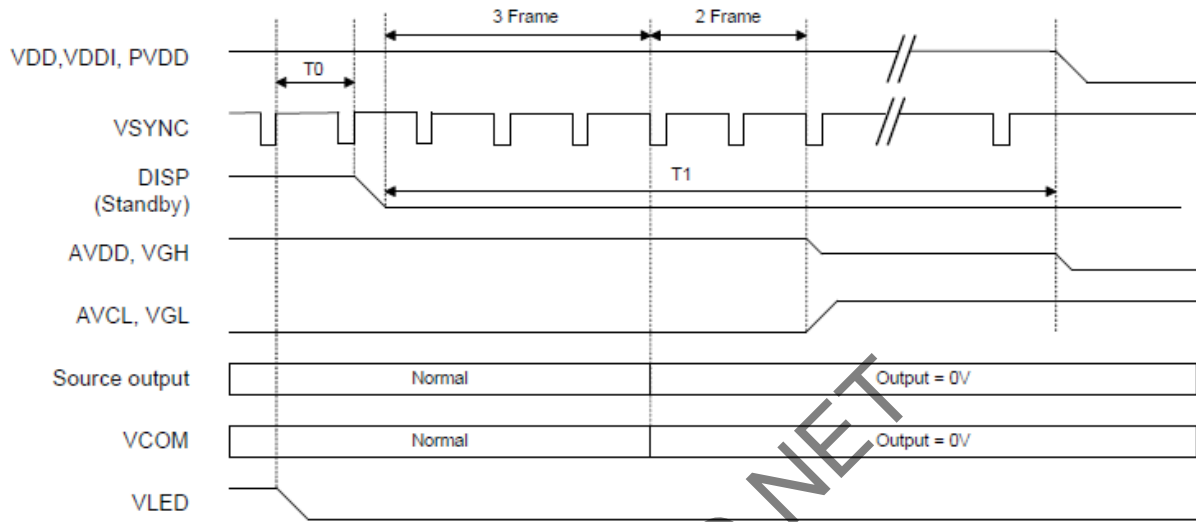

	Description	Min. Time
T0	Time from backlight power off to DISP="L"	1*Frame
T1	Time from DISP="L" to LCM Power off	5*Frame

10. Quality Assurance

10.1 Purpose

This standard for Quality Assurance assures the quality of LCD module products supplied to customer.

10.2 Standard for Quality Test

10.2.1 Sampling Plan:

GB2828.1-2012

Single sampling, general inspection level II

10.2.2 Sampling Criteria:

Visual inspection: AQL 1.5%

Electrical functional: AQL 0.65%.

10.2.3 Reliability Test:

Detailed requirement refer to Reliability Test Specification.

10.3 Nonconforming Analysis & Disposition

10.3.1 Nonconforming analysis:

10.3.1.1 Customer should provide overall information of non-conforming sample for their complaints.

10.3.1.2 After receipt of detailed information from customer, the analysis of nonconforming parts usually should be finished in one week.

10.3.1.3 If can not finish the analysis on time, customer will be notified with the progress status.

10.3.2 Disposition of nonconforming:

10.3.2.1 Non-conforming product over PPM level will be replaced.

10.3.2.2 The cause of non-conformance will be analyzed. Corrective action will be discussed and implemented.

10.4 Agreement Items

Shall negotiate with customer if the following situation occurs:

10.4.1 There is any discrepancy in standard of quality assurance.

10.4.2 Additional requirement to be added in product specification.

10.4.3 Any other special problem.

10.5 Standard of the Product Visual Inspection

10.5.1 Appearance inspection:

10.5.1.1 The inspection must be under illumination about 1000 – 1500 lx, and the distance of view must be at 30cm ± 2cm.

10.5.1.2 The viewing angle should be 45° from the vertical line without reflection light or follows customer's viewing angle specifications.

10.5.1.3 Definition of area: A Zone: Active Area, B Zone: Viewing Area,

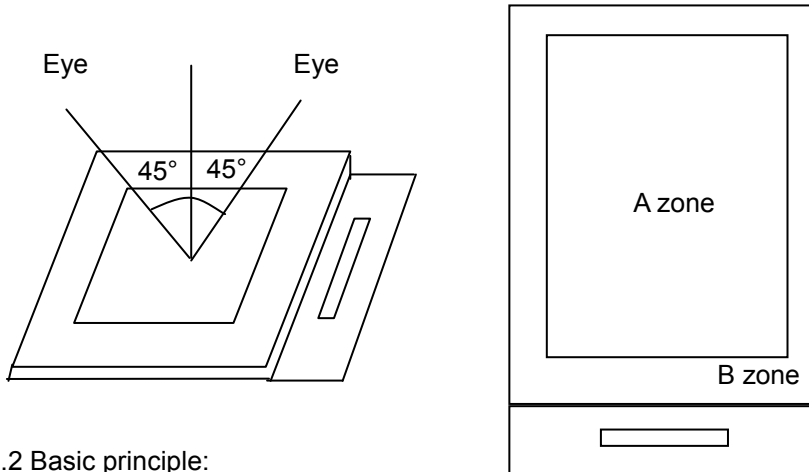

10.5.2 Basic principle:

10.5.2.1 A set of sample to indicate the limit of acceptable quality level must be discussed by both us and customer when there is any dispute happened.

10.5.2.2 New item must be added on time when it is necessary.

10.6 Inspection Specification

No.	Item	Criteria (Unit: mm)																			
01	Black / White spot Foreign material (Round type) Pinholes Stain Particles inside cell. (Minor defect)	$\phi = (a + b) / 2$	<table border="1"> <thead> <tr> <th>Size \ Area</th> <th>Acc. Qty</th> </tr> </thead> <tbody> <tr> <td>$\phi \leq 0.10$</td> <td>Ignore</td> </tr> <tr> <td>$0.10 < \phi \leq 0.15$</td> <td>2</td> </tr> <tr> <td>$0.15 < \phi \leq 0.25$</td> <td>1</td> </tr> <tr> <td>$0.25 < \phi$</td> <td>0</td> </tr> <tr> <td>Total</td> <td>2 no include $\phi \leq 0.10$</td> </tr> </tbody> </table>	Size \ Area	Acc. Qty	$\phi \leq 0.10$	Ignore	$0.10 < \phi \leq 0.15$	2	$0.15 < \phi \leq 0.25$	1	$0.25 < \phi$	0	Total	2 no include $\phi \leq 0.10$						
			Size \ Area	Acc. Qty																	
$\phi \leq 0.10$	Ignore																				
$0.10 < \phi \leq 0.15$	2																				
$0.15 < \phi \leq 0.25$	1																				
$0.25 < \phi$	0																				
Total	2 no include $\phi \leq 0.10$																				
Distance between 2 defects should more than 3mm apart.																					
02	Electrical Defect (Minor defect)	<table border="1"> <thead> <tr> <th></th> <th>Display Area</th> <th>Total</th> <th rowspan="3">Note1</th> </tr> </thead> <tbody> <tr> <td>Bright dot</td> <td>0</td> <td>0</td> </tr> <tr> <td>Dark dot</td> <td>N ≤ 2</td> <td>N ≤ 2</td> </tr> <tr> <td>Total dot</td> <td>N ≤ 2</td> <td>N ≤ 2</td> <td></td> </tr> <tr> <td>Mura</td> <td colspan="2">Not visible through 5% ND filters.</td> <td>Note 2</td> </tr> </tbody> </table>			Display Area	Total	Note1	Bright dot	0	0	Dark dot	N ≤ 2	N ≤ 2	Total dot	N ≤ 2	N ≤ 2		Mura	Not visible through 5% ND filters.		Note 2
			Display Area	Total	Note1																
		Bright dot	0	0																	
		Dark dot	N ≤ 2	N ≤ 2																	
Total dot	N ≤ 2	N ≤ 2																			
Mura	Not visible through 5% ND filters.		Note 2																		
Remark:																					
1. Bright dot caused by scratch and foreign object accords to item 1.																					

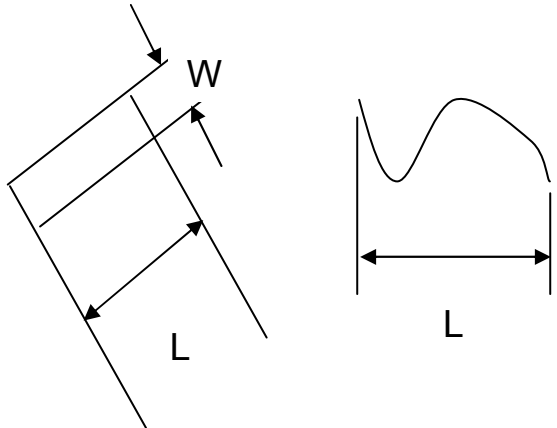
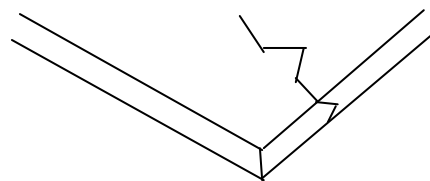
<p>03</p>	<p>Black and White line Scratch Foreign material (Line type) (Minor defect)</p>	 <table border="1" data-bbox="614 828 1236 1137"> <thead> <tr> <th>Length</th> <th>Width</th> <th>Acc. Qty</th> </tr> </thead> <tbody> <tr> <td>/</td> <td>$W \leq 0.03$</td> <td>Ignore</td> </tr> <tr> <td>$L \leq 2.5$</td> <td>$0.03 < W \leq 0.05$</td> <td>3</td> </tr> <tr> <td>$L \leq 2.5$</td> <td>$0.05 < W \leq 0.10$</td> <td>2</td> </tr> <tr> <td>/</td> <td>$0.1 < W$</td> <td>0</td> </tr> <tr> <td colspan="2">Total</td> <td>3</td> </tr> </tbody> </table> <p>Distance between 2 defects should more than 3mm apart. Scratches not viewable through the back of the display are acceptable.</p>	Length	Width	Acc. Qty	/	$W \leq 0.03$	Ignore	$L \leq 2.5$	$0.03 < W \leq 0.05$	3	$L \leq 2.5$	$0.05 < W \leq 0.10$	2	/	$0.1 < W$	0	Total		3
Length	Width	Acc. Qty																		
/	$W \leq 0.03$	Ignore																		
$L \leq 2.5$	$0.03 < W \leq 0.05$	3																		
$L \leq 2.5$	$0.05 < W \leq 0.10$	2																		
/	$0.1 < W$	0																		
Total		3																		
<p>04</p>	<p>Glass Crack (Minor defect)</p>	 <p>Crack is potential to enlarge, any type is not allowed.</p>																		

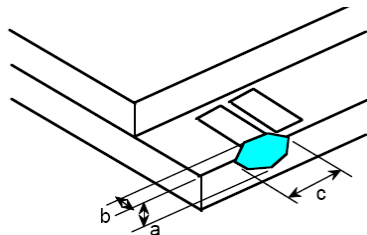
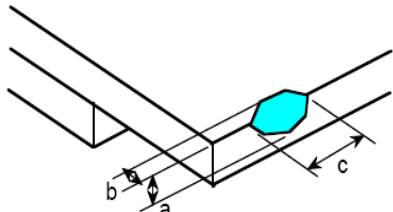
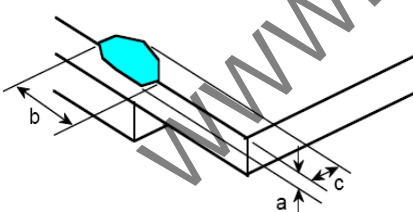
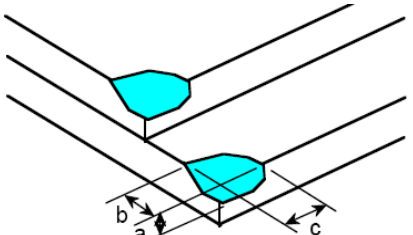
<p>05</p>	<p>Glass Chipping Pad Area: (Minor defect)</p> 	<table border="1"> <thead> <tr> <th>Length and Width</th> <th>Acc. Qty</th> </tr> </thead> <tbody> <tr> <td>$c > 3.0, b < 1.0$</td> <td>1</td> </tr> <tr> <td>$c < 3.0, b < 1.0$</td> <td>3</td> </tr> <tr> <td colspan="2" style="text-align: center;">$a < \text{Glass Thickness}$</td> </tr> </tbody> </table>	Length and Width	Acc. Qty	$c > 3.0, b < 1.0$	1	$c < 3.0, b < 1.0$	3	$a < \text{Glass Thickness}$			
Length and Width	Acc. Qty											
$c > 3.0, b < 1.0$	1											
$c < 3.0, b < 1.0$	3											
$a < \text{Glass Thickness}$												
<p>06</p>	<p>Glass Chipping Rear of Pad Area: (Minor defect)</p> 	<table border="1"> <thead> <tr> <th>Length and Width</th> <th>Acc. Qty</th> </tr> </thead> <tbody> <tr> <td>$c > 3.0, b < 1.0$</td> <td>1</td> </tr> <tr> <td>$c < 3.0, b < 1.0$</td> <td>2</td> </tr> <tr> <td>$c < 3.0, b < 0.5$</td> <td>4</td> </tr> <tr> <td colspan="2" style="text-align: center;">$a < \text{Glass Thickness}$</td> </tr> </tbody> </table>	Length and Width	Acc. Qty	$c > 3.0, b < 1.0$	1	$c < 3.0, b < 1.0$	2	$c < 3.0, b < 0.5$	4	$a < \text{Glass Thickness}$	
Length and Width	Acc. Qty											
$c > 3.0, b < 1.0$	1											
$c < 3.0, b < 1.0$	2											
$c < 3.0, b < 0.5$	4											
$a < \text{Glass Thickness}$												
<p>07</p>	<p>Glass Chipping Except Pad Area: (Minor defect)</p> 	<table border="1"> <thead> <tr> <th>Length and Width</th> <th>Acc. Qty</th> </tr> </thead> <tbody> <tr> <td>$c > 3.0, b < 1.0$</td> <td>1</td> </tr> <tr> <td>$c < 3.0, b < 1.0$</td> <td>2</td> </tr> <tr> <td>$c < 3.0, b < 0.5$</td> <td>4</td> </tr> <tr> <td colspan="2" style="text-align: center;">$a < \text{Glass Thickness}$</td> </tr> </tbody> </table>	Length and Width	Acc. Qty	$c > 3.0, b < 1.0$	1	$c < 3.0, b < 1.0$	2	$c < 3.0, b < 0.5$	4	$a < \text{Glass Thickness}$	
Length and Width	Acc. Qty											
$c > 3.0, b < 1.0$	1											
$c < 3.0, b < 1.0$	2											
$c < 3.0, b < 0.5$	4											
$a < \text{Glass Thickness}$												
<p>08</p>	<p>Glass Corner Chipping: (Minor defect)</p> 	<table border="1"> <thead> <tr> <th>Length and Width</th> <th>Acc. Qty</th> </tr> </thead> <tbody> <tr> <td>$c < 3.0, b < 3.0$</td> <td>Ignore</td> </tr> <tr> <td colspan="2" style="text-align: center;">$a < \text{Glass Thickness}$</td> </tr> </tbody> </table>	Length and Width	Acc. Qty	$c < 3.0, b < 3.0$	Ignore	$a < \text{Glass Thickness}$					
Length and Width	Acc. Qty											
$c < 3.0, b < 3.0$	Ignore											
$a < \text{Glass Thickness}$												

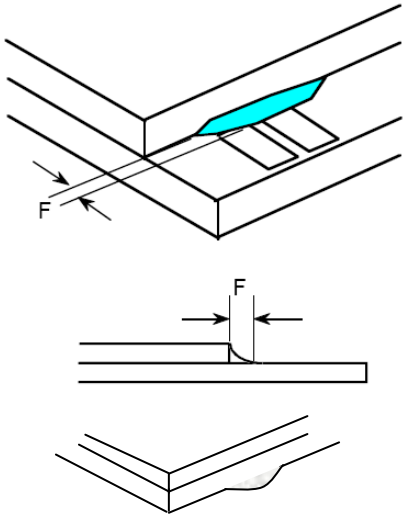
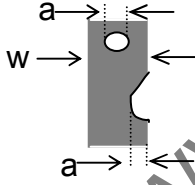
09	<p>Glass Burr: (Minor defect)</p> 	<table border="1" data-bbox="810 517 1283 607"> <thead> <tr> <th>Length</th> <th>Acc. Qty</th> </tr> </thead> <tbody> <tr> <td>$F < 1.0$</td> <td>Ignore</td> </tr> </tbody> </table> <p>Glass burr don't affect assemble and module dimension.</p>	Length	Acc. Qty	$F < 1.0$	Ignore				
Length	Acc. Qty									
$F < 1.0$	Ignore									
10	<p>FPC Defect: (Minor defect)</p> 	<p>9.1 Dent, pinhole width $a < w/3$. (w: circuitry width.)</p> <p>9.2 Open circuit is unacceptable.</p> <p>9.3 No oxidation, contamination and distortion.</p>								
11	<p>Bubble on Polarizer (Minor defect)</p>	<table border="1" data-bbox="684 1406 1157 1581"> <thead> <tr> <th>Diameter</th> <th>Acc. Qty</th> </tr> </thead> <tbody> <tr> <td>$\varphi \leq 0.20$</td> <td>Ignore</td> </tr> <tr> <td>$0.20 < \varphi \leq 0.30$</td> <td>4</td> </tr> <tr> <td>$0.30 < \varphi$</td> <td>None</td> </tr> </tbody> </table>	Diameter	Acc. Qty	$\varphi \leq 0.20$	Ignore	$0.20 < \varphi \leq 0.30$	4	$0.30 < \varphi$	None
Diameter	Acc. Qty									
$\varphi \leq 0.20$	Ignore									
$0.20 < \varphi \leq 0.30$	4									
$0.30 < \varphi$	None									
12	<p>Dent on Polarizer (Minor defect)</p>	<table border="1" data-bbox="684 1650 1157 1825"> <thead> <tr> <th>Diameter</th> <th>Acc. Qty</th> </tr> </thead> <tbody> <tr> <td>$\varphi \leq 0.20$</td> <td>Ignore</td> </tr> <tr> <td>$0.20 < \varphi \leq 0.30$</td> <td>4</td> </tr> <tr> <td>$0.30 < \varphi$</td> <td>None</td> </tr> </tbody> </table>	Diameter	Acc. Qty	$\varphi \leq 0.20$	Ignore	$0.20 < \varphi \leq 0.30$	4	$0.30 < \varphi$	None
Diameter	Acc. Qty									
$\varphi \leq 0.20$	Ignore									
$0.20 < \varphi \leq 0.30$	4									
$0.30 < \varphi$	None									
13	<p>Bezel</p>	<p>12.1 No rust, distortion on the Bezel.</p> <p>12.2 No visible fingerprints, stains or other contamination.</p>								

14	Touch Panel	<p>D: Diameter W: width L: length</p> <p>13.1 Spot: $D < 0.25$ is acceptable $0.25 \leq D \leq 0.4$</p> <p>2dots are acceptable and the distance between defects should more than 10 mm.</p> <p>$D > 0.4$ is unacceptable</p> <p>13.2 Dent: $D > 0.40$ is unacceptable</p> <p>13.3 Scratch: $W \leq 0.03$, $L \leq 10$ is acceptable, $0.03 < W \leq 0.10$, $L \leq 10$ is acceptable</p> <p>Distance between 2 defects should more than 10 mm. $W > 0.10$ is unacceptable.</p>
15	PCB	<p>14.1 No distortion or contamination on PCB terminals.</p> <p>14.2 All components on PCB must same as documented on the BOM/component layout.</p> <p>14.3 Follow IPC-A-600F.</p>
16	Soldering	Follow IPC-A-610C standard
17	Electrical Defect (Major defect)	<p>The below defects must be rejected.</p> <p>16.1 Missing vertical / horizontal segment,</p> <p>16.2 Abnormal Display.</p> <p>16.3 No function or no display.</p> <p>16.4 Current exceeds product specifications.</p> <p>16.5 LCD viewing angle defect.</p> <p>16.6 No Backlight.</p> <p>16.7 Dark Backlight.</p> <p>16.8 Touch Panel no function.</p> <p>16.9 Dark Dot –one Allowed.</p> <p>16.10 Bright Dot – one Allowed.</p> <p>Remark:</p> <p>1. A pixel defect is acceptable if one color is none functional and causes a bright dot. The display may have one case where one color is out and cause a dark dot.</p> <p>2. Bright dot caused by scratch and foreign object accords to item 1.</p>

Remark: LCD Panel Broken shall be rejected. Defect out of LCD viewing area is acceptable.

10.7 Classification of Defects

10.7.1 Visual defects (Except no / wrong label) are treated as minor defect and electrical defect is major.

10.7.2 Two minor defects are equal to one major in lot sampling inspection.

10.8 Identification/marketing criteria

Any unit with illegible / wrong /double or no marking/ label shall be rejected.

10.9 Packing

10.9.1 There should be no damage of the outside carton box, each packaging box should have one identical label.

10.9.2 Modules inside package box should have compliant mark.

10.9.3 All direct package materials shall offer ESD protection

Note1: Bright dot is defined as the defective area of the dot is larger than 50% of one sub-pixel area.

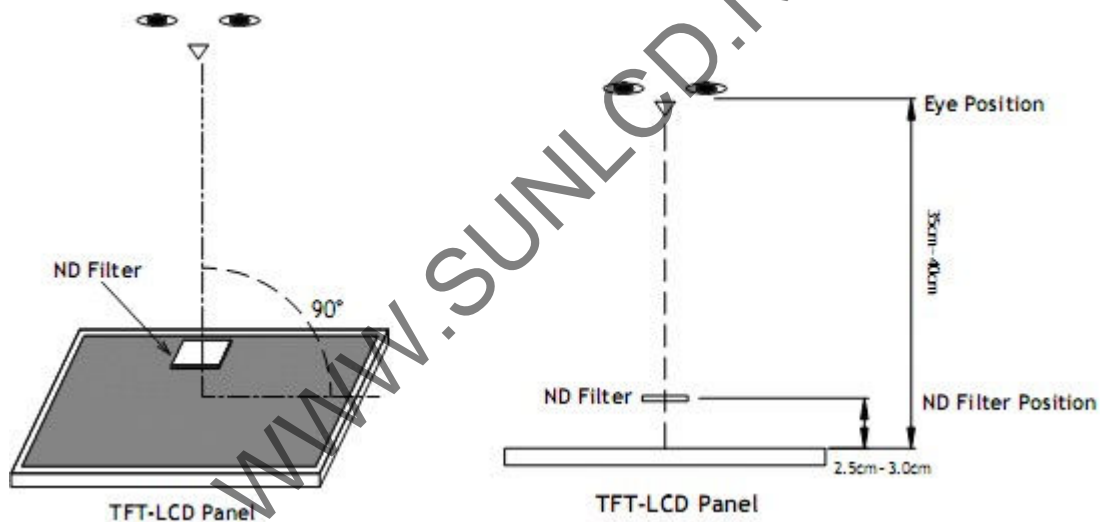

Bright dot: The bright dot size defect at black display pattern. It can be recognized by 2% transparency of filter when the distance between eyes and panel is $350\text{mm} \pm 50\text{mm}$.

Dark dot: Cyan, Magenta or Yellow dot size defect at white display pattern. It can be recognized by 5% transparency of filter when the distance between eyes and panel is $350\text{mm} \pm 50\text{mm}$.

Note2: Mura on display which appears darker / brighter against background brightness on parts of display area.

11. Reliability Specification

No	Item	Condition	Quantity	Criteria
1	High Temperature Operating	70°C, 96Hrs	2	GB/T2423.2-2008
2	Low Temperature Operating	-20°C, 96Hrs	2	GB/T2423.1-2008
3	High Humidity	50°C, 90%RH, 96Hrs	2	GB/T2423.3-2006
4	High Temperature Storage	80°C, 96Hrs	2	GB/T2423.2-2008
5	Low Temperature Storage	-30°C, 96Hrs	2	GB/T2423.1-2008
6	Thermal Cycling Test	-20°C, 60min~ 70°C, 60min, 20 cycles.	2	GB/T2423.22-2012
7	Packing vibration	Frequency range:10Hz~50Hz Acceleration of gravity:5G X, Y, Z 30 min for each direction.	2	GB/T5170.14-2009
8	Drop Test (Packaged)	Height:80 cm, 1 corner, 3 edges, 6 surfaces.	2	GB/T2423.8-1995

Note1. No defection cosmetic and operational function allowable.

Note2. Total current Consumption should be below double of initial value

12. Precautions and Warranty

12.1 Safety

12.1.1 The liquid crystal in the LCD is poisonous. Do not put it in your mouth. If the liquid crystal touches your skin or clothes, wash it off immediately using soap and water.

12.1.2 Since the liquid crystal cells are made of glass, do not apply strong impact on them. Handle with care.

12.2 Handling

12.2.1 Reverse and use within ratings in order to keep performance and prevent damage.

12.2.2 Do not wipe the polarizer with dry cloth, as it might cause scratch. If the surface of the LCD needs to be cleaned, wipe it swiftly with cotton or other soft cloth soaked with petroleum IPA, do not use other chemicals.

12.3 Storage

12.3.1 Do not store the LCD module beyond the specified temperature ranges.

12.4 Metal Pin (Apply to Products with Metal Pins)

12.4.1 Pins of LCD and Backlight

12.4.1.1 Solder tip can touch and press on the tip of Pin LEAD during the soldering

12.4.1.2 Recommended Soldering Conditions

Solder Type: Sn96.3~94-Ag3.3~4.3-Cu0.4~1.1

Maximum Solder Temperature: 370°C

Maximum Solder Time: 3s at the maximum temperature

Recommended Soldering Temp: 350±20°C

Typical Soldering Time: ≤3s

12.4.1.3 Solder Wetting

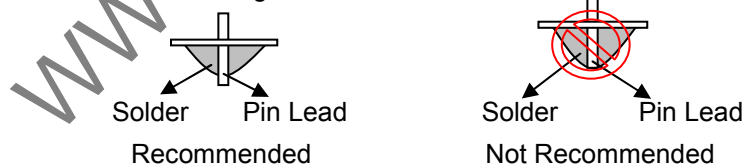

12.4.2 Pins of EL

12.4.2.1 Solder tip can touch and press on the tip of EL leads during soldering.

12.4.2.2 No Solder Paste on the soldering pad on the motherboard is recommended.

12.4.2.3 Recommended Soldering Conditions

Solder type: Nippon Alimit Leadfree SR-34, size 0.5mm

Recommended Solder Temperature: 270~290°C

Typical Soldering Time: ≤2s

Minimum solder distance from EL lamp (body):2.0mm

12.4.1.4 No horizontal press on the EL leads during soldering.

12.4.1.5 180° bend EL leads three times is not allowed.

12.4.1.6 Solder Wetting

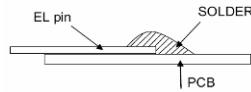

Recommended

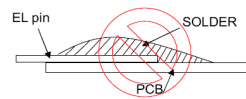

Not Recommended

12.4.1.7 The type of the solder iron:

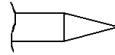

Recommended

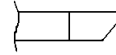

Not Recommended

12.4.1.8 Solder Pad

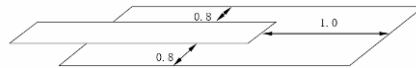

12.5 Operation

- 12.5.1 Do not drive LCD with DC voltage
- 12.5.2 Response time will increase below lower temperature
- 12.5.3 Display may change color with different temperature
- 12.5.4 Mechanical disturbance during operation, such as pressing on the display area, may cause the segments to appear "fractured".

12.6 Static Electricity

- 12.6.1 CMOS LSIs are equipped in this unit, so care must be taken to avoid the electro-static charge, by ground human body, etc.
- 12.6.2 The normal static prevention measures should be observed for work clothes and benches.
- 12.6.3 The module should be kept into anti-static bags or other containers resistant to static for storage.

12.7 Limited Warranty

- 12.7.1 Our warranty liability is limited to repair and/or replacement. We will not be responsible for any consequential loss.
- 12.7.2 If possible, we suggest customer to use up all modules in six months. If the module storage time over twelve months, we suggest that recheck it before the module be used
- 12.7.3 After the product shipped, any product quality issues must be feedback within three months, otherwise, we will not be responsible for the subsequent or consequential events.

13. Packaging

TBD

WWW.SUNLCD.NET

14. Outline Drawing

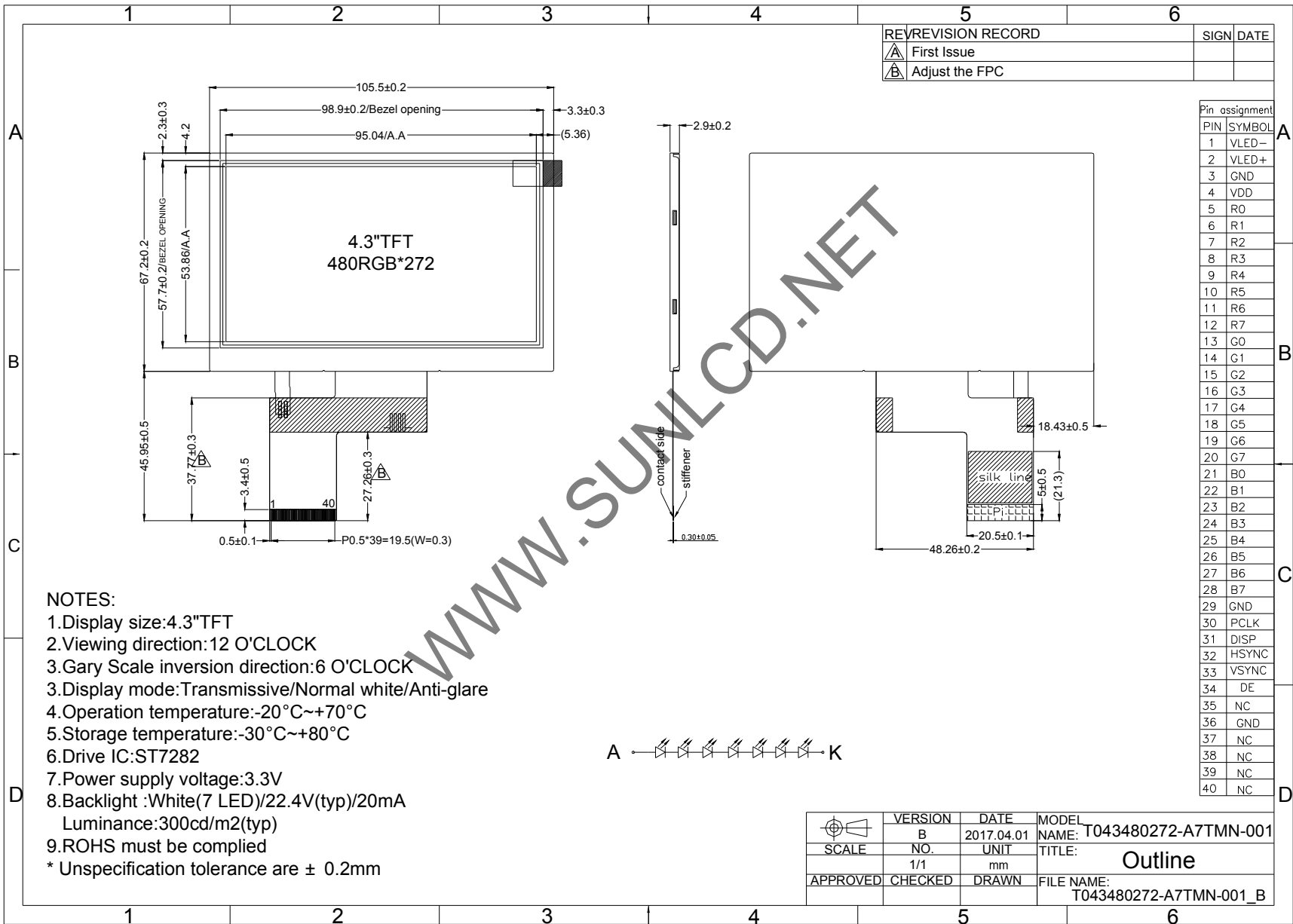

REV/REVISION RECORD		SIGN	DATE
△	First Issue		
⊠	Adjust the FPC		

PIN	SYMBOL
1	VLED-
2	VLED+
3	GND
4	VDD
5	RO
6	R1
7	R2
8	R3
9	R4
10	R5
11	R6
12	R7
13	G0
14	G1
15	G2
16	G3
17	G4
18	G5
19	G6
20	G7
21	B0
22	B1
23	B2
24	B3
25	B4
26	B5
27	B6
28	B7
29	GND
30	PCLK
31	DISP
32	HSYNC
33	VSYNC
34	DE
35	NC
36	GND
37	NC
38	NC
39	NC
40	NC

- NOTES:
1. Display size: 4.3" TFT
 2. Viewing direction: 12 O'CLOCK
 3. Gary Scale inversion direction: 6 O'CLOCK
 3. Display mode: Transmissive/Normal white/Anti-glare
 4. Operation temperature: -20°C~+70°C
 5. Storage temperature: -30°C~+80°C
 6. Drive IC: ST7282
 7. Power supply voltage: 3.3V
 8. Backlight : White(7 LED)/22.4V(typ)/20mA
Luminance: 300cd/m2(typ)
 9. ROHS must be complied
- * Unspecification tolerance are ± 0.2mm



VERSION	DATE	MODEL
B	2017.04.01	T043480272-A7TMN-001
SCALE	NO.	UNIT
	1/1	mm
APPROVED	CHECKED	DRAWN
FILE NAME:		
T043480272-A7TMN-001_B		